

DENSELIGHT SEMICONDUCTORS PTE. LTD.
6 Changi North St. 2, S498831 SINGAPORE
Tel: (65) 6415 4488
Fax: (65) 6415 7988
www.denselight.com

SPECIFICATIONS

Pulsed Ultra Narrow Linewidth 1648nm Laser In BTF Package

DL-CLS259B-S1648

DenseLight Semiconductors reserves the right to make product design or specifications changes without notice.

A. PRODUCT DESCRIPTION

DenseLight **DL-CLS259B-S1648** is a pulsed and cooled ultra narrow linewidth laser in BTF package with SMF pigtail emitting at 1648nm wavelength. This laser is based on an external cavity laser with built-in fiber Bragg grating, offering very stable performance of lasing wavelength, narrow spectral linewidth and excellent SMSR.

B. FEATURES

- Strained InGaAsP/InP MQW gain chip coupled with built-in fiber Bragg grating
- Pulsed single mode optical output of >25 mW
- Lasing wavelength of 1648 nm
- Minimum SMSR of 45 dB
- Internal thermoelectric cooler and thermistor
- RoHS Compliance

C. PACKAGING

- 14-pin BTF package with SMF-28 pigtail

D. APPLICATIONS

- OTDR
- Optical measuring instrumentation
- Optical gas and chemical sensor

E. ABSOLUTE MAXIMUM RATINGS

Parameter	Symbol	Condition	Min	Max	Unit
Reverse voltage	V_R			2	V
Forward current	I_F	pulse width = 10 μ s, duty = 1%		425	mA
Forward voltage	V_F	I_{op}		3.5	V
Case temperature	T_c	I_{op}	0	60	$^{\circ}$ C
Laser temperature ¹	T_{Laser}	I_{op}	0	70	$^{\circ}$ C
Thermoelectric cooler voltage	V_{TEC}			3.0	V
Thermoelectric cooler current	I_{TEC}			1.8	A
Storage temperature	T_{stg}	Unbiased	-40	85	$^{\circ}$ C
Storage humidity			5	85	%RH
Electro static discharge (ESD)	V_{ESD}	Human body model		500	V
Lead soldering temperature	S_{temp}			260	$^{\circ}$ C
Lead soldering time	S_{time}			10	sec

¹ T_{Laser} is monitored by internal thermistor with external pin out.

F. ELECTRICAL AND OPTICAL CHARACTERISTICS ($T_{Laser} = 25^{\circ}$ C, unless otherwise noted)

Parameter	Symbol	Test Conditions	Min	Typ	Max	Unit
Threshold current	I_{th}	CW	–	25	35	mA
Optical output power	P_o	Pulsed width=10 μ s, duty=1%, 25 mW	25	–	–	mW
Operating current	I_{op}	Pulsed width=10 μ s, duty=1%, 25 mW	–	–	375	mA
Operation voltage	V_{op}	Pulsed width=10 μ s, duty=1%, 25 mW	–	–	3.3	V
Peak wavelength	λ_p	CW, 5mW, 50 mA (typ)	1646	1648	1650	nm
Side mode suppression ratio	SMSR	CW, 5mW, 50 mA (typ)	45	–	–	dB
Linewidth ²	$\Delta\lambda$	CW, 5mW	–	200	–	kHz
Pulse shape	V_{peak}/V_{min}	Pulsed width=10 μ s, duty=1%, 25 mW	–	–	1.5	–
	V_{max}/V_{min}		–	–	1.33	–
Thermistor resistance	R_{therm}	$T_{therm} = 25^{\circ}$ C	9.5	10	10.5	k Ω

² Typical linewidth is narrowed to < 10kHz when module is integrated inside DenseLight's BF-series box with high precision laser driver & temperature controller.

G. PACKAGE

Part	Description
Package type	14-pin BTF
Fiber:	SMF-28
MFD	9 μ m
Cladding diameter	125 μ m
Coating diameter	245 μ m
Fiber pigtail length	>1m
Fiber connector	FC/APC

H. OUTLINE DRAWINGS

Typical Package Dimension

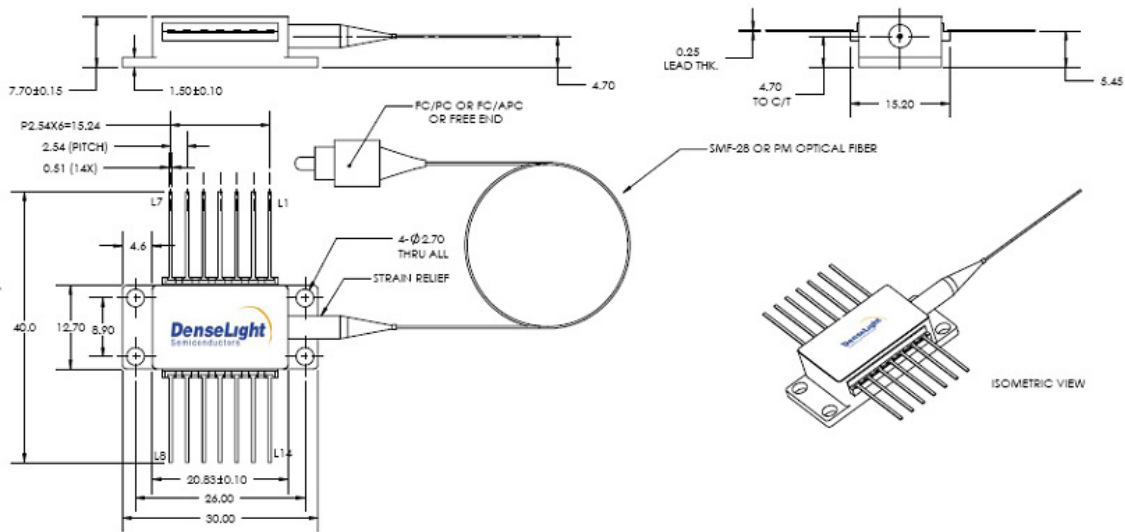

Pin Assignment	
1	TEC (+)
2	THERMISTOR
3	
4	
5	THERMISTOR
6	-
7	-
8	-
9	-
10	LD ANODE (+)
11	LD CATHODE (-)
12	-
13	CASE
14	TEC (-)

